

No	a * b	X
1	450 x 450	2
2	2196 x 498	2
3	418 x 248	4
4	300 x 497	2
5	450 x 248	2
6	2168 x 551	1
7	1001 x 551	1
8	1001 x 551	1
9	1892 x 497	2
10	450 x 248	2
11	280 x 551	1
12	968 x 551	1
13	968 x 551	1
14	2168 x 551	1
15	150 x 968	2

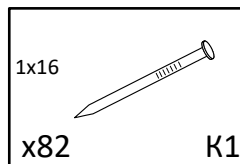

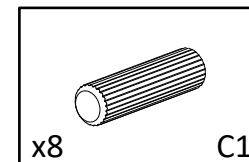

1

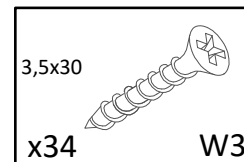
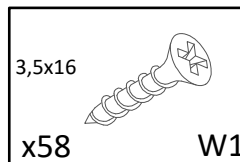
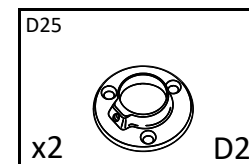
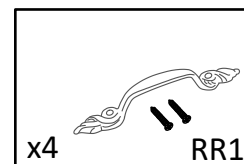
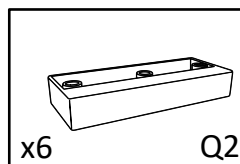
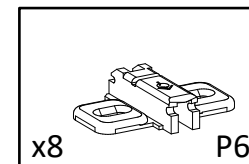
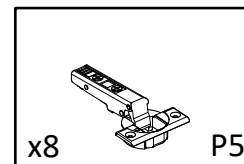
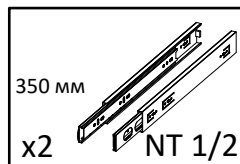
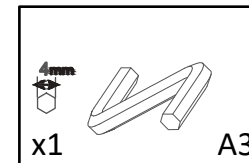
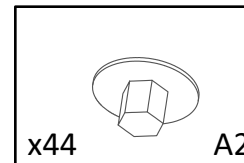
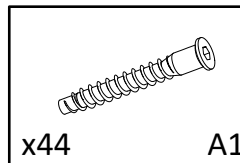
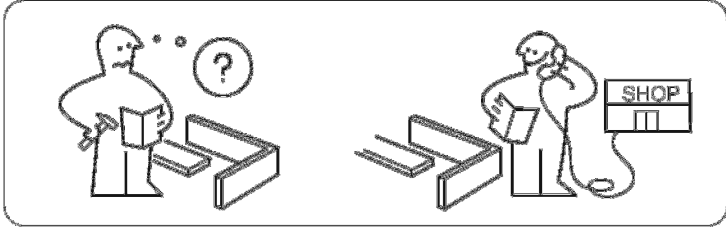
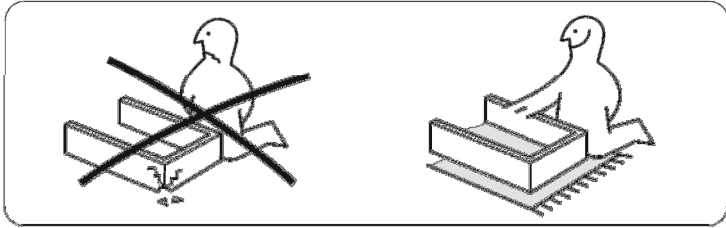
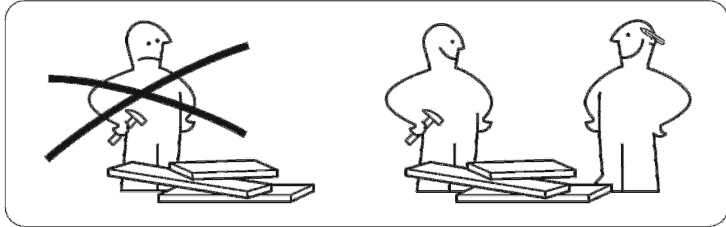
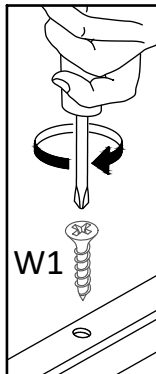
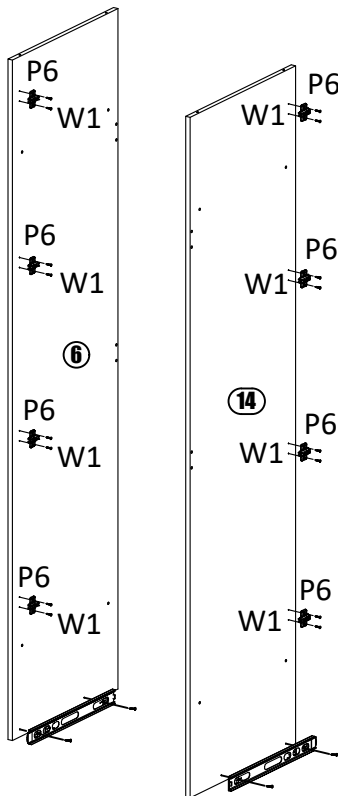
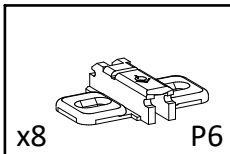
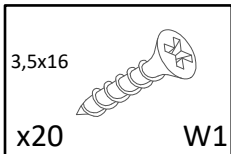
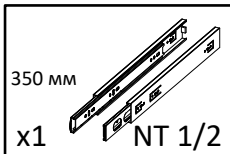

2

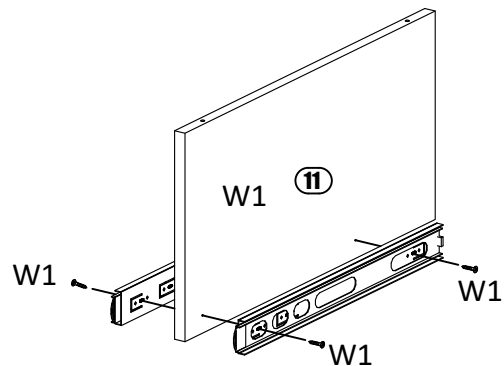
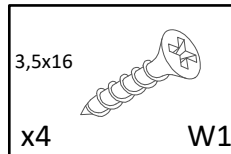
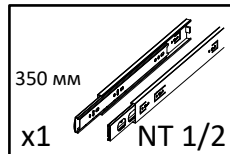

3

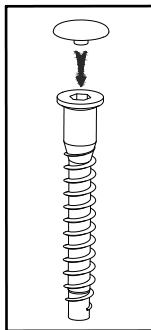
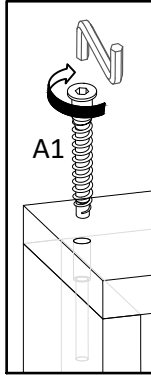
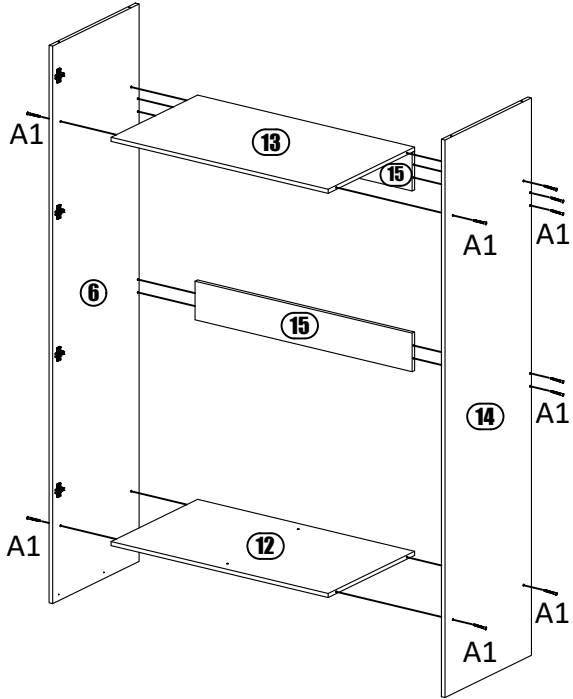
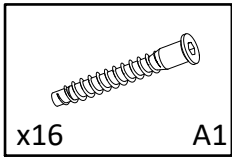

4

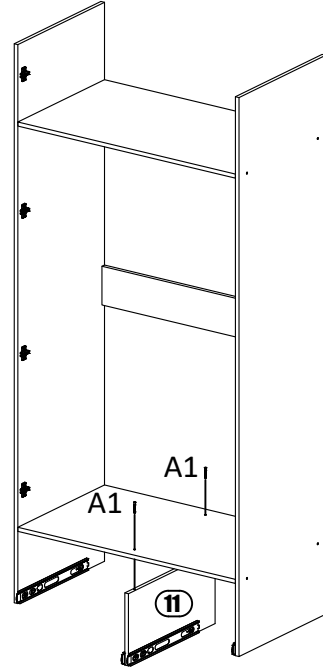
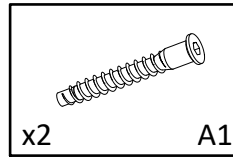

7

1x16

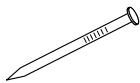

x56

K1

x1



ZP

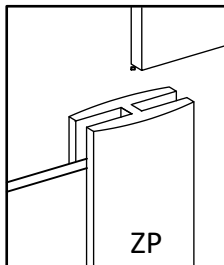
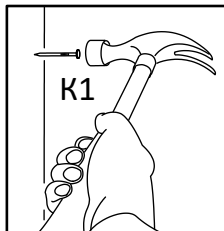
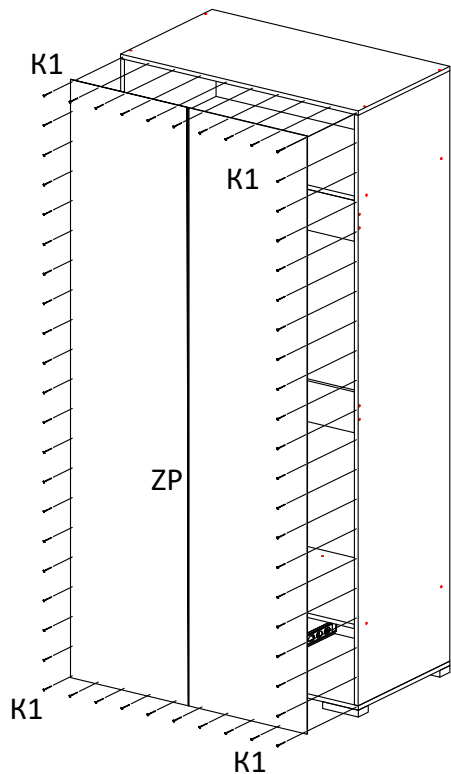

8

x2

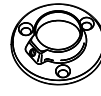

D2

3,5x16

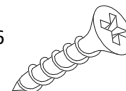

x6

W1

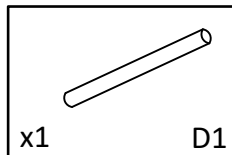

x1

D1

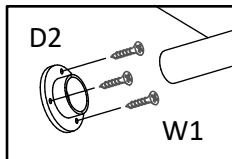

D2

W1

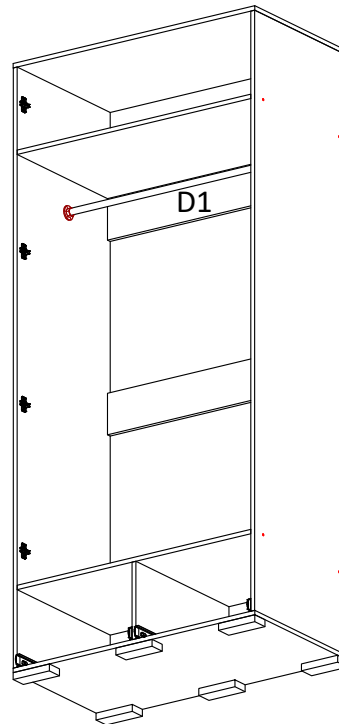

9

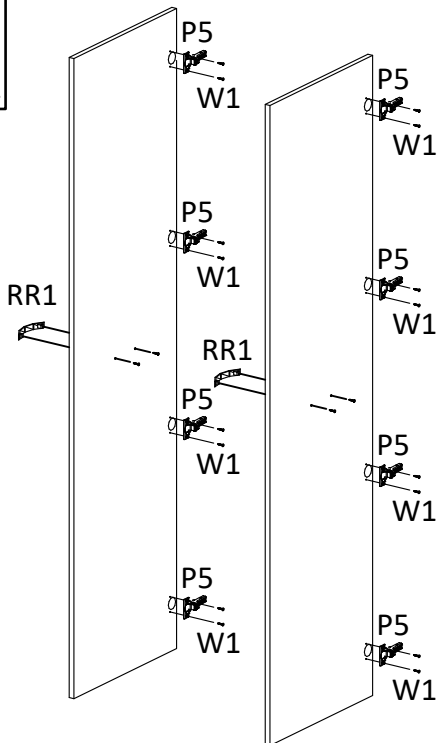
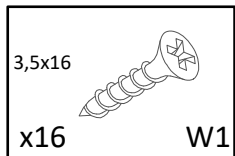
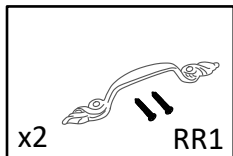
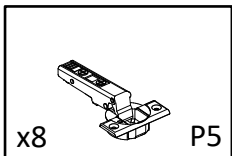

10

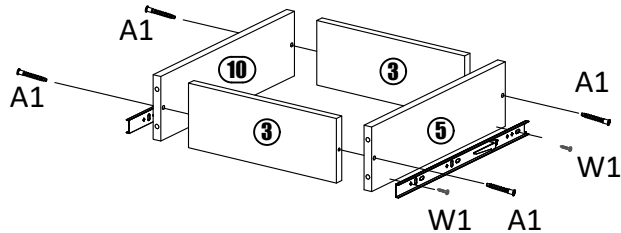
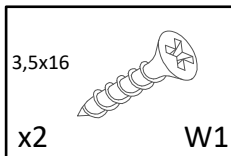
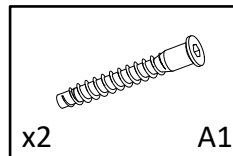
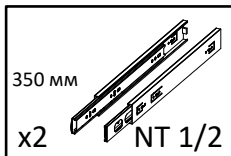

11

1x16

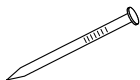

x13

K1

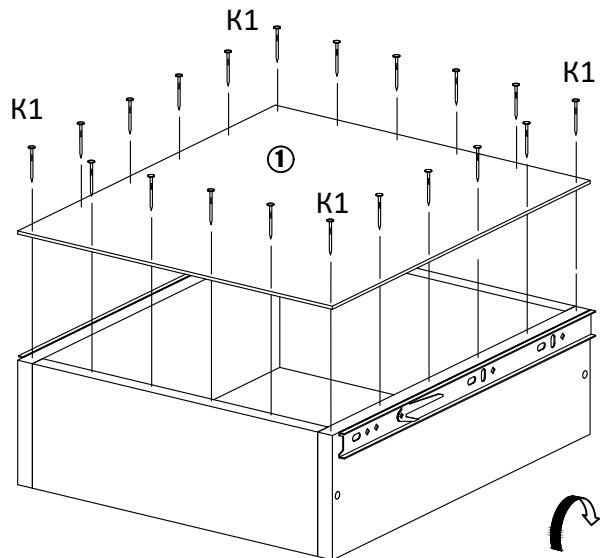

12

(DN)



x1

RR1

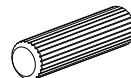

x4

C1

3,5x30

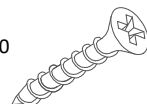

x4

W3

